

Apéndice XII

**Diagramas elaborados por DIAGEN de la
navegación de los alumnos a través de
HiperCinemática**

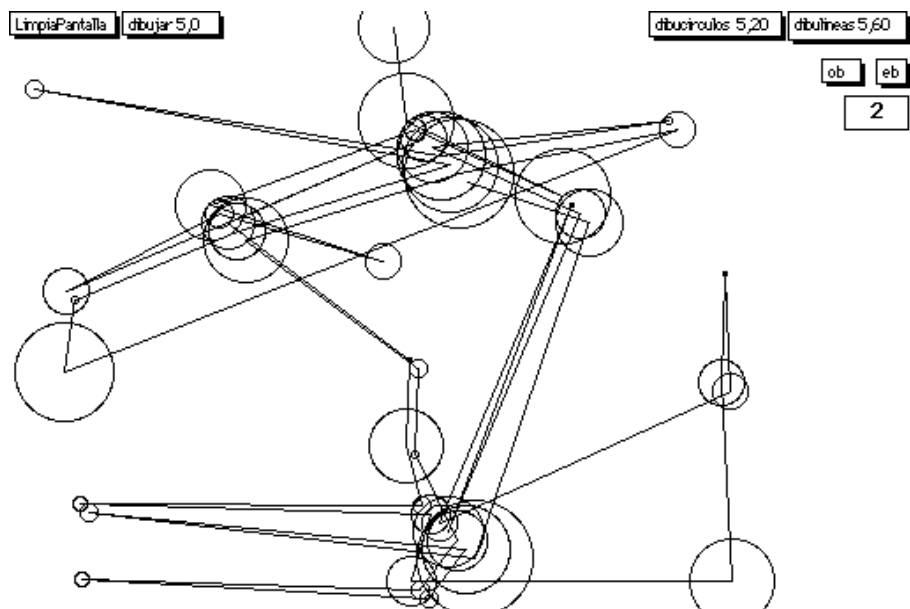

Diagramas elaborados por DIAGEN de la navegación de los alumnos a través de HiperCinemática

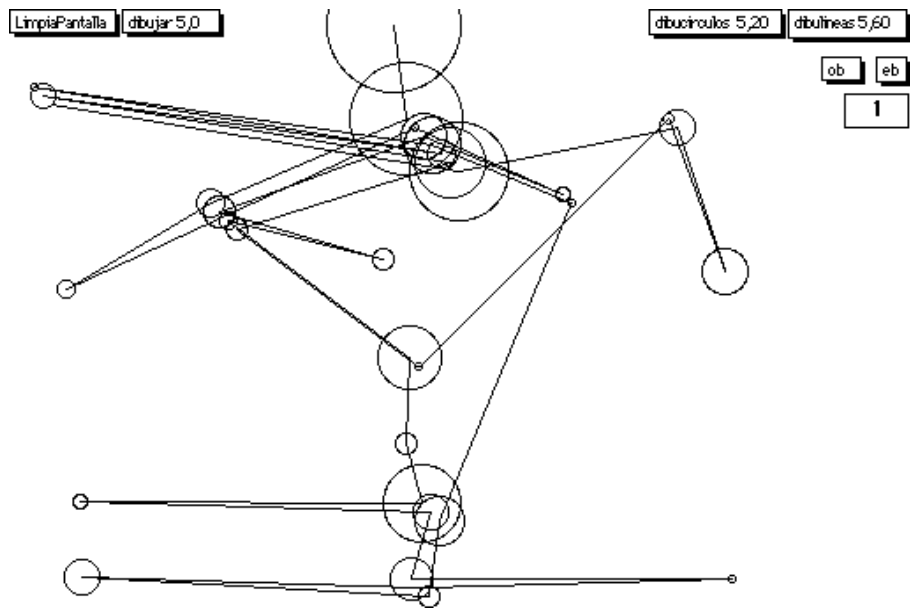
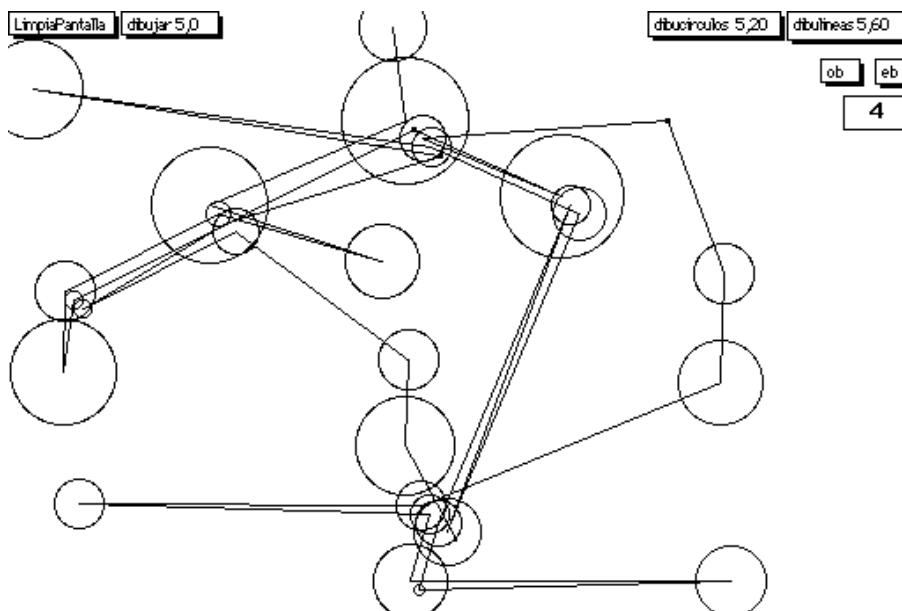
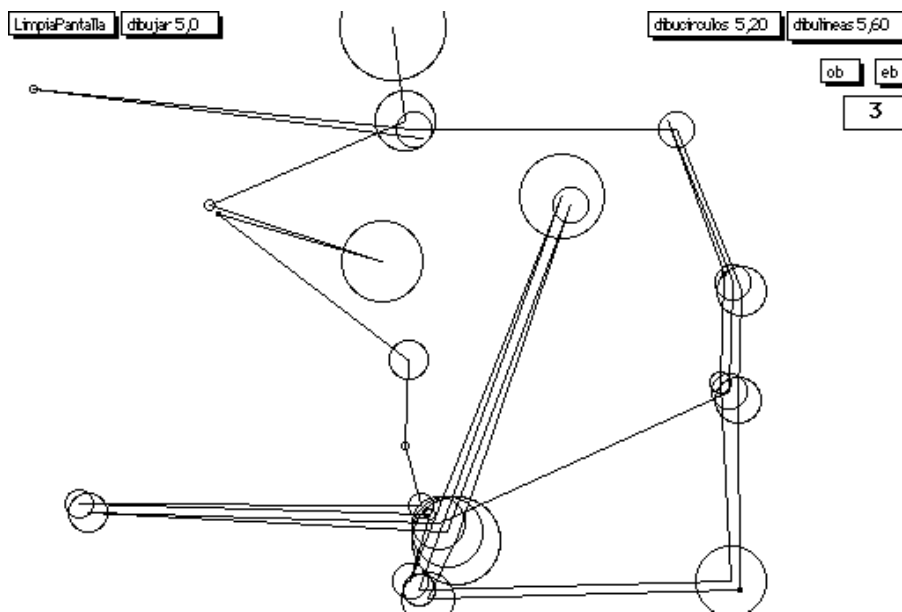

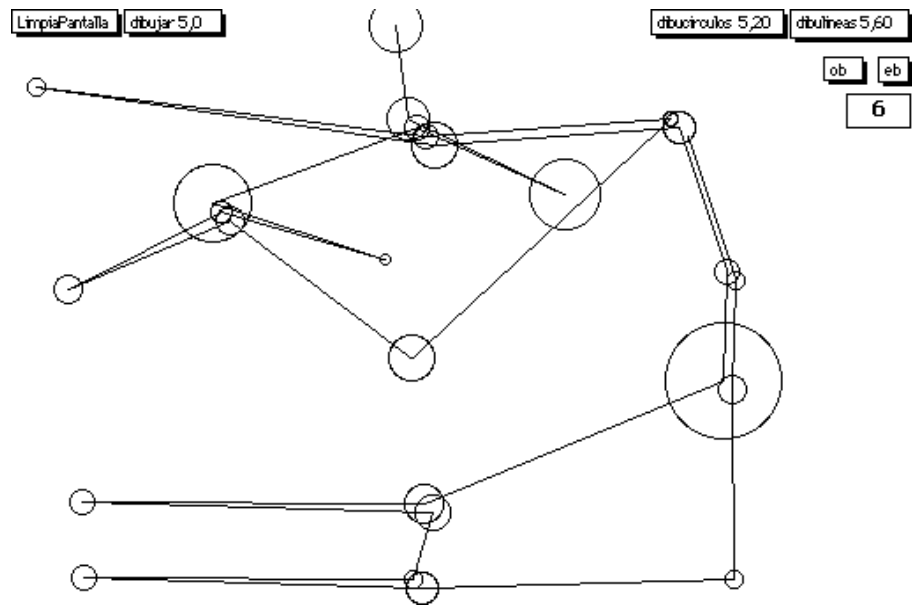
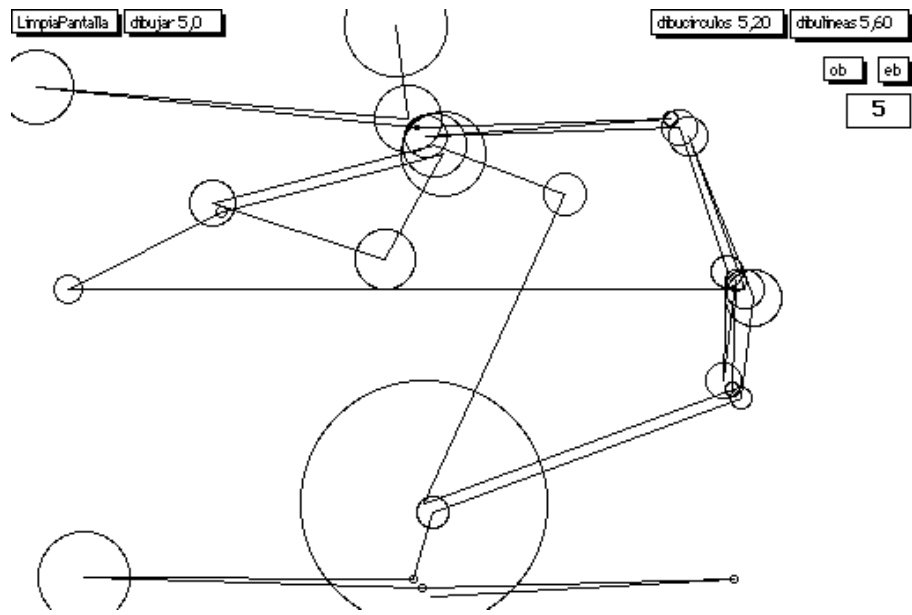

Diagramas elaborados por DIAGEN de la navegación de los alumnos a través de HiperCinemática

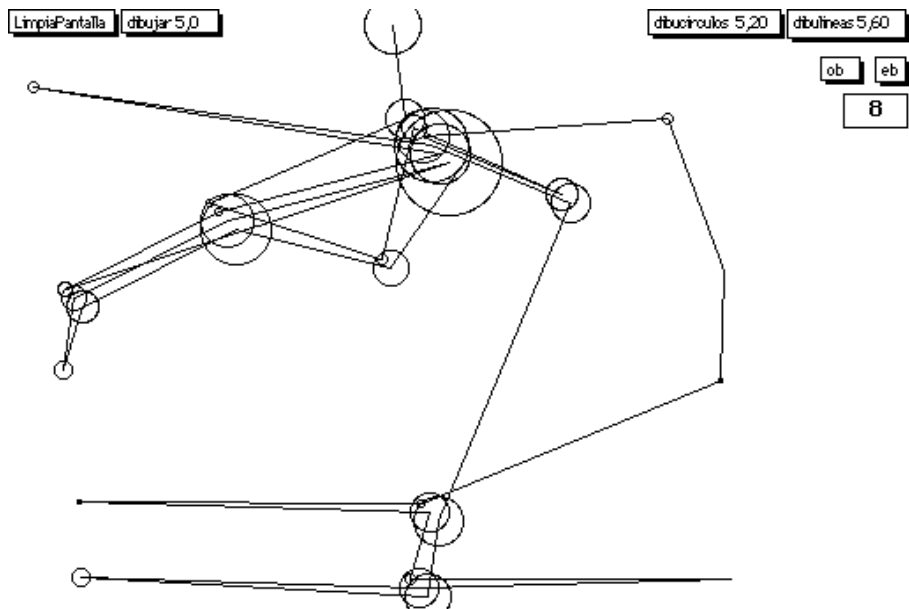
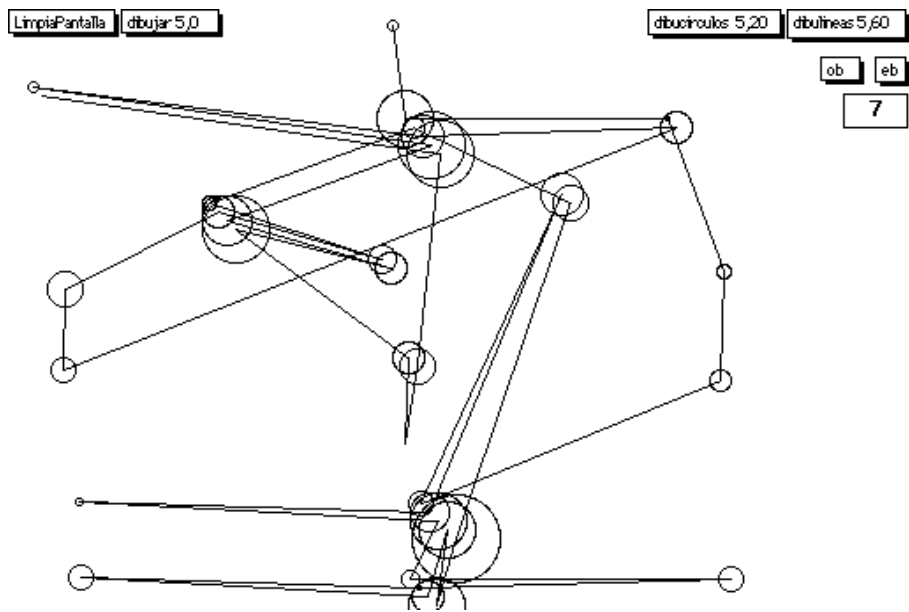

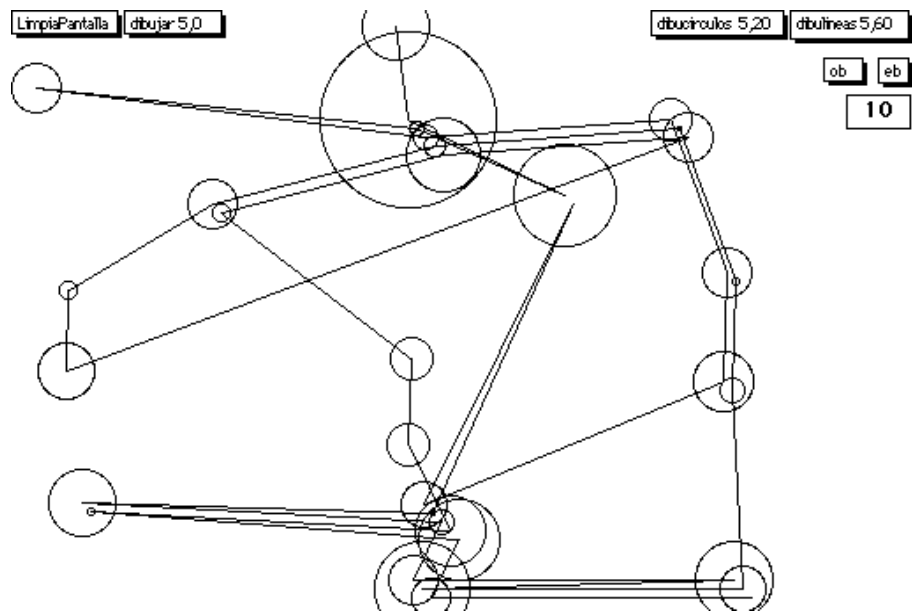
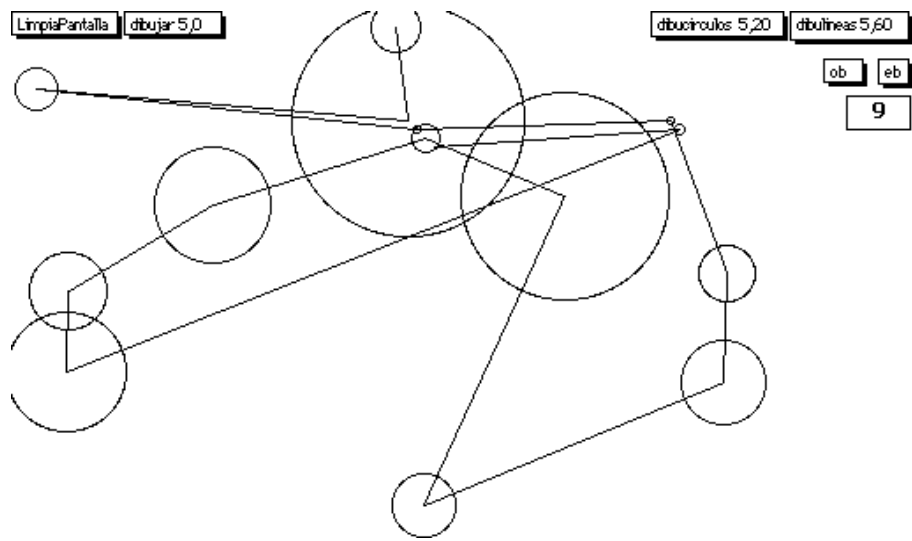

Diagramas elaborados por DIAGEN de la navegación de los alumnos a través de HiperCinemática

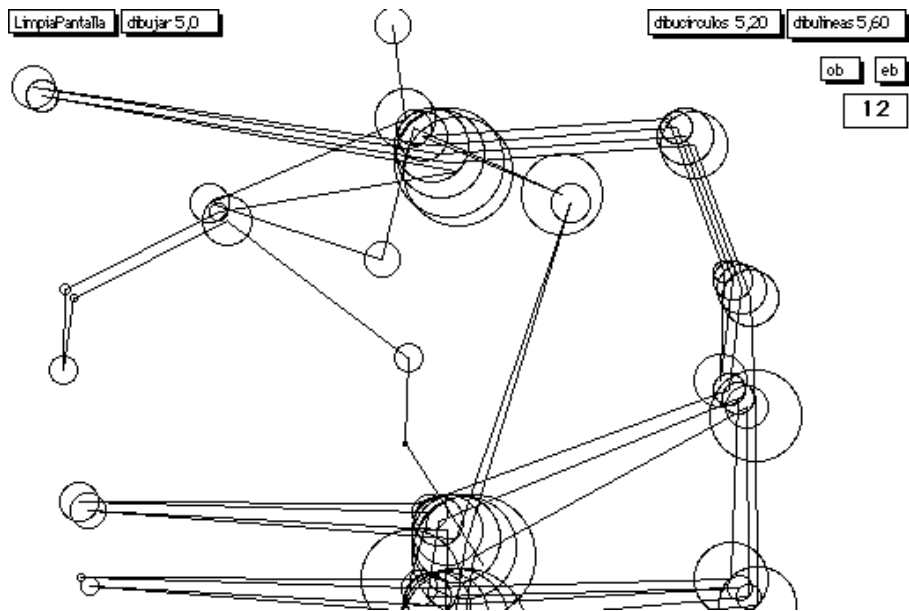
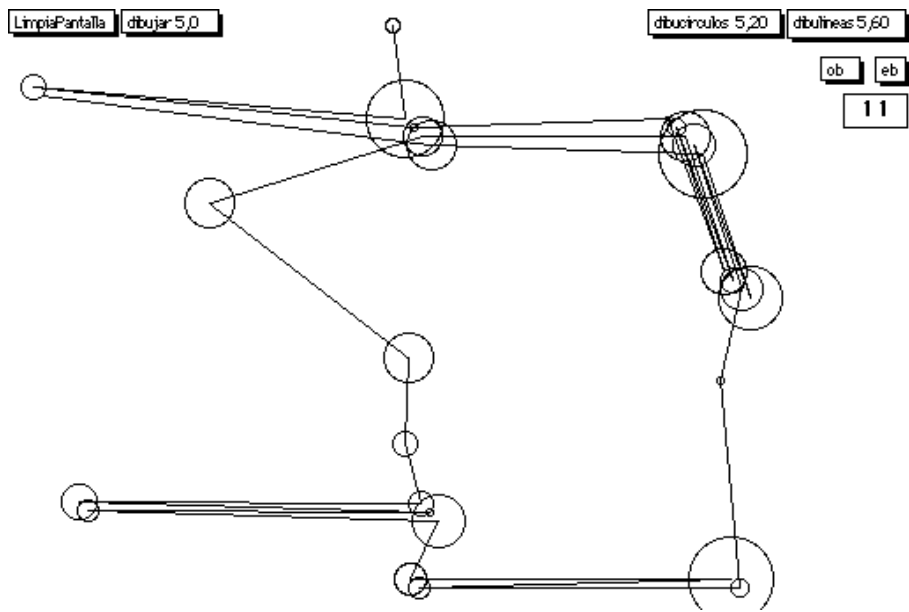

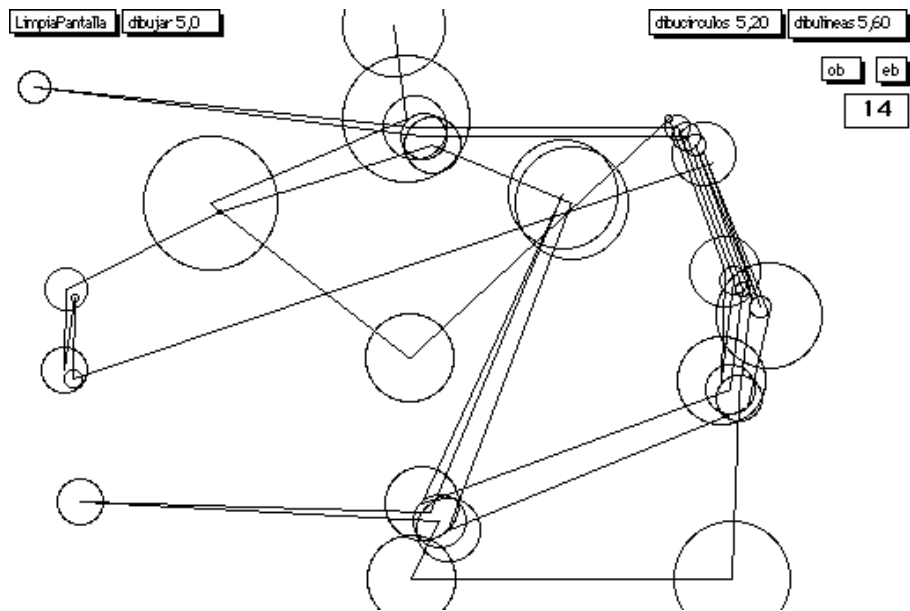
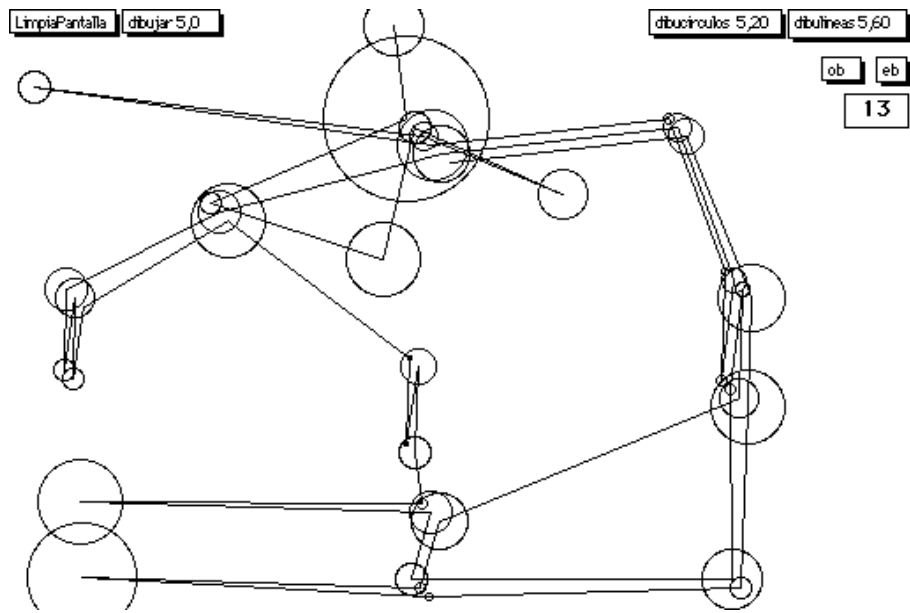

Diagramas elaborados por DIAGEN de la navegación de los alumnos a través de HiperCinemática

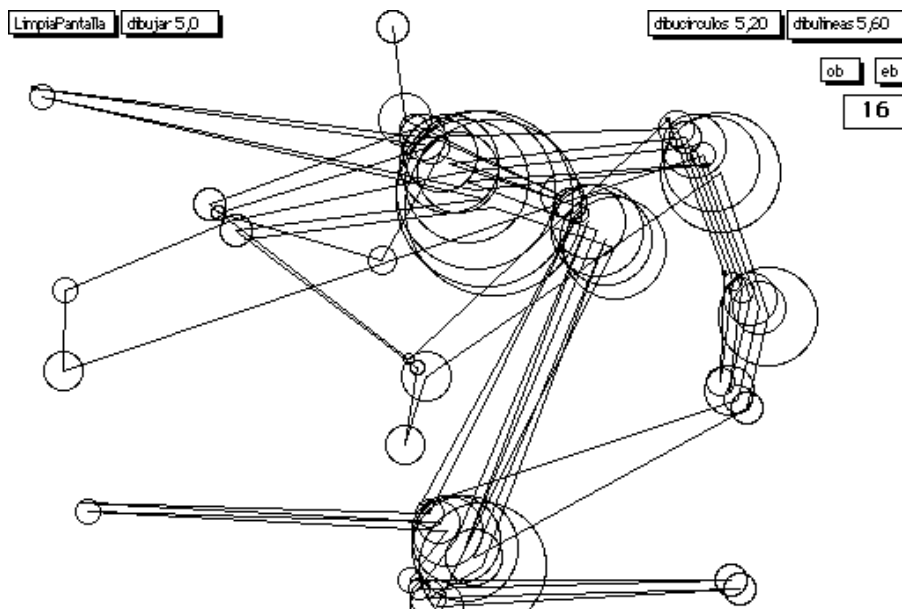
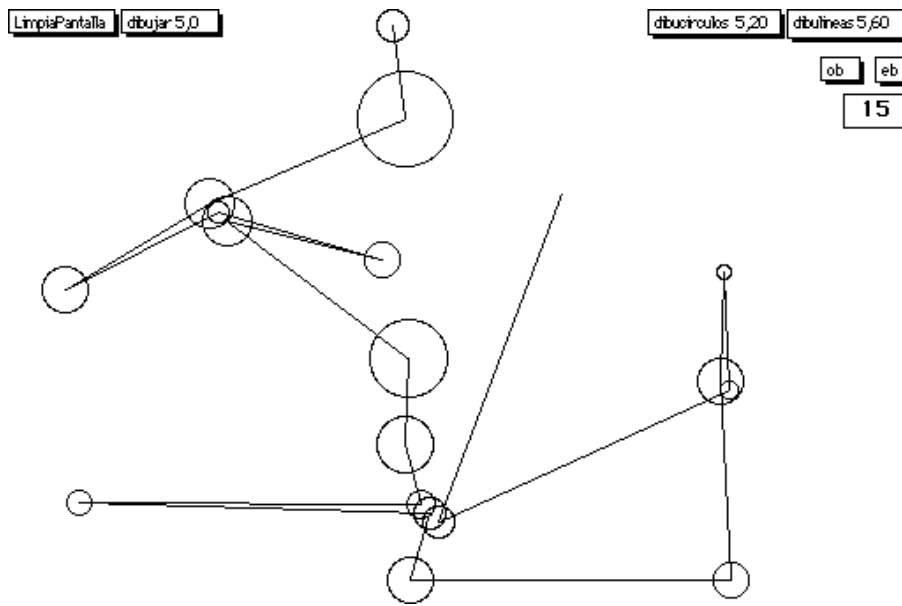

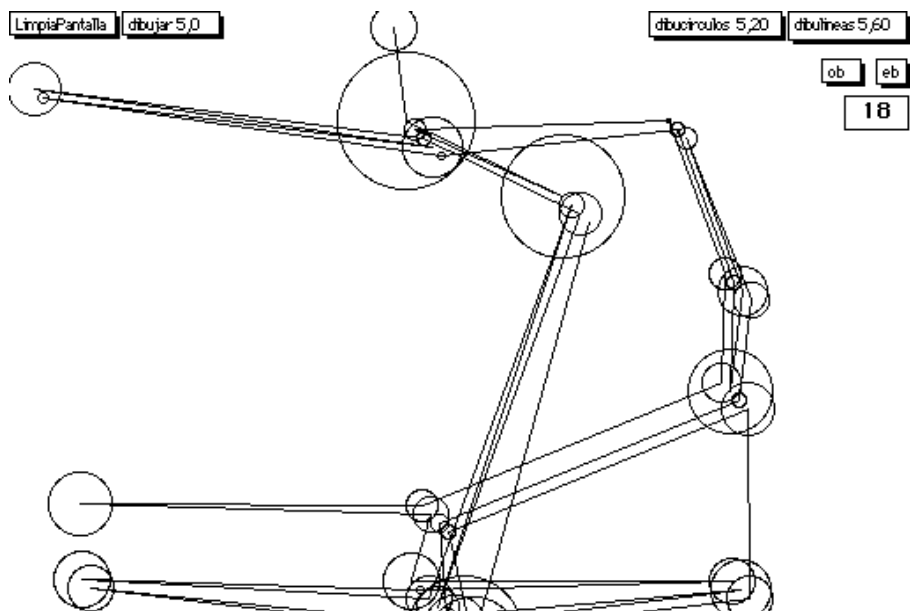
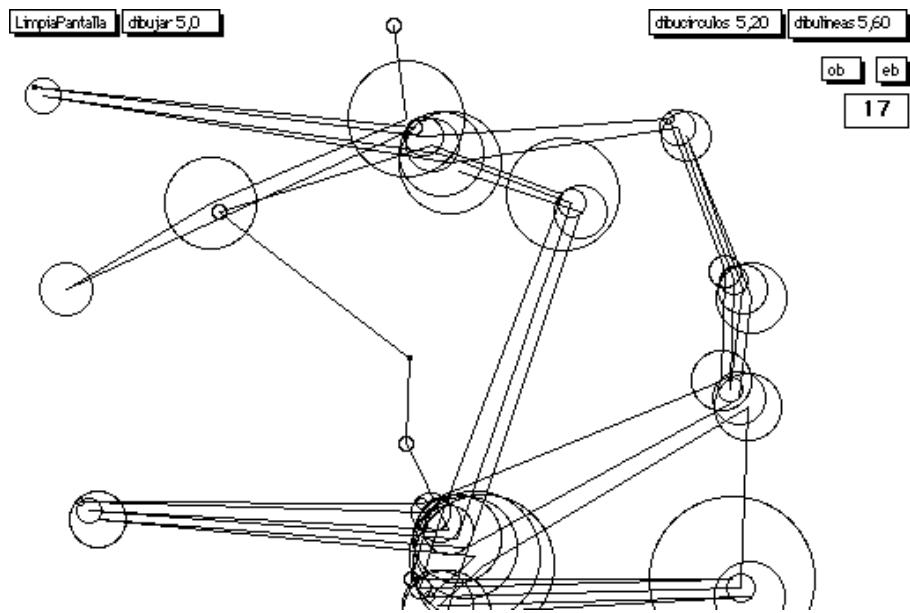

Diagramas elaborados por DIAGEN de la navegación de los alumnos a través de HiperCinématica

